

# KX15DT

15m Dual-Technology Detector



EN50131-2-2:2008  
EN50131-1:2006+A1:2009  
PD6662:2010

IMQ Security Grade (SG) 2  
Environmental Class (EC) II

## ENGLISH (Diagram references)

- Disassembling the KX
- The Printed Circuit Board (PCB)
  - A Alarm LED
  - B Resistor Headers (Tamper / Alarm)
  - C Mains Frequency
  - D Sensitivity (Auto/High) - see section.6
  - E 'AND/OR' Mode- see section.7
  - F Pyro Sensor (DO NOT TOUCH)
  - G Microwave Potentiometer (adjust)
  - H

- Cable Entry / Mounting
- Bracket Mounting Options

**5 Installation Hints:** Do not partially or completely obscure the detector's field of view with large objects such as furniture.  
**Avoiding False Alarms:** When the detector is first powered up, it will run through a self-test routine, indicated by the flashing LEDs. Once this has extinguished - the detector is ready to use.  
 1: Avoid Placing the detector in direct sunlight. 2: Do not let pets and other animals wander freely whilst the alarm system is armed.  
 3: Do not mount the detector near heaters or radiators.  
 4: Do not mount the detector near open windows or air vents.

- Sensitivity Settings: A Auto Sensitivity (Default) B High Sensitivity

**7 AND/OR Mode:** "AND" - Conventional Dual-Tech (both technologies need to be triggered simultaneously to generate an alarm)  
 "OR" - If either single technology detects an intruder activity an alarm will be generated.

**8 Microwave Potentiometer:** - Minimum Range (0m), Maximum Range (15m)  
**Note:** Turning the pot fully anti-clockwise turns off the microwave.

**9 EOL Resistor Headers:** The KX15DQ has 2 sets of header pins (as shown). These headers are used to select the End of Line resistance for EOL wiring applications.  
**NOTE: If EOL wiring is not used, leave the headers OFF.**

- A N/C - Normally Closed Wiring (EXAMPLE ONLY, SEE CONTROL PANEL INSTRUCTIONS)
  - B Single End of Line Wiring (EXAMPLE ONLY, SEE CONTROL PANEL INSTRUCTIONS)
  - C DEOL Wiring (EXAMPLE ONLY, SEE CONTROL PANEL INSTRUCTIONS)
  - D 2x Double End of Line Detectors to One Input (SEE CONTROL PANEL INSTRUCTIONS)
  - E Zone Doubling Example

**11 Powering Up:** When the detector is first powered up, it will run through a self-test routine (indicated by the flashing blue LED). Once the LED goes out the detector is ready to use.

- The 15m Volumetric Lens.
- Dimensions and Weight

**Technical Specification**  
 Model: KX15DT Colour: White LED Colours: Orange (Microwave), Blue (Alarm), Green (PIR)  
 Casing: 3mm ABS, 0.4mm HDPE in lens area  
 Detection Method: Low noise dual element pyroelectric sensor & Microwave doppler sensor  
 PIR Sensitivity: Auto (Default), High Temperature Compensation: Digital  
 Detection Range: 15m (13m by EN50131-2-2 & INCERT criteria) Detection Speed: 0.3 - 3.0 m/s  
 Operating Voltage: 9 - 16VDC 13.8V DC typical  
 Current Consumption: 24mA @ 12V (Min), 30mA @ 12V (Max)  
 Relay Output: 50mA 60V DC, 42 VAC (RMS) Contact Resistance: < 10 Ω Mounting  
 Height: 1.8m - 3m (best place 2.4 m) Tamper Switch: 12V 50mA Temperature:  
 -40°C to 80°C (storage) -10°C to 40°C (certified) -30°C to 70°C (nominal) Accessories: Wall  
 and Ceiling brackets Emissions: EN55022 Class B Immunity: EN50130-4  
 Protection against EMI and RF  
 Compatible with Curtain Lens (Not Included) KX18LC, 15 m and 5° coverage

### Warranty & Compliance

This product is sold subject to our standard warranty conditions and is warranted against defects in workmanship for a period of five years. For further warranty information visit:  
[www.pyronix.com/warranty](http://www.pyronix.com/warranty)

The declaration of conformity and further compliance documentation may be consulted at:  
[www.pyronix.com/product-compliance.php](http://www.pyronix.com/product-compliance.php)

### Contact Information

For electrical products sold within the European Community. At the end of the electrical products life, it should not be disposed of with household waste. Please recycle where facilities exist. Check with your Local Authority or retailer for recycling advice in your country. This product is approved for use in the Residential, Commercial and Light Industrial Environments.

Secure Holdings, Pyronix Ltd,  
 Braithwell Way, Hellaby,  
 Rotherham, South Yorkshire  
 S66 8QY  
 UK



## START

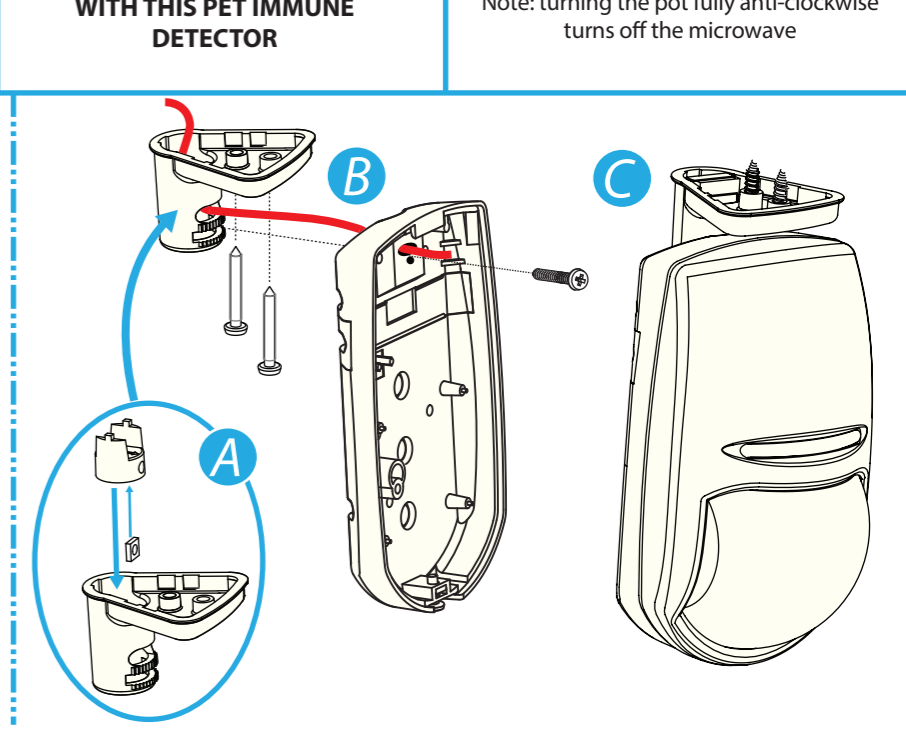
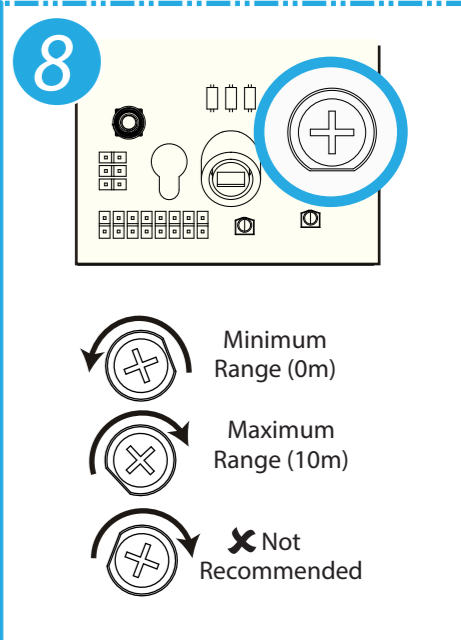
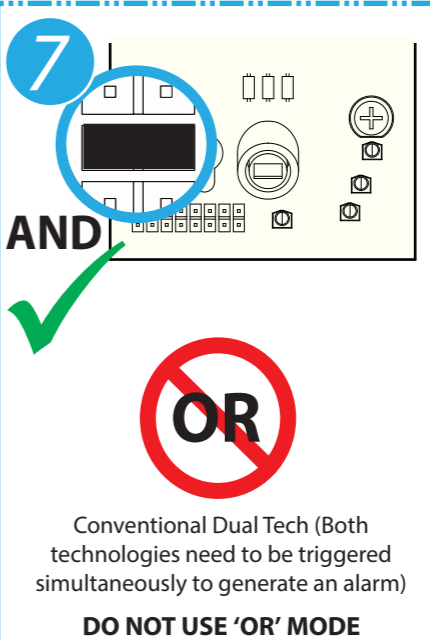
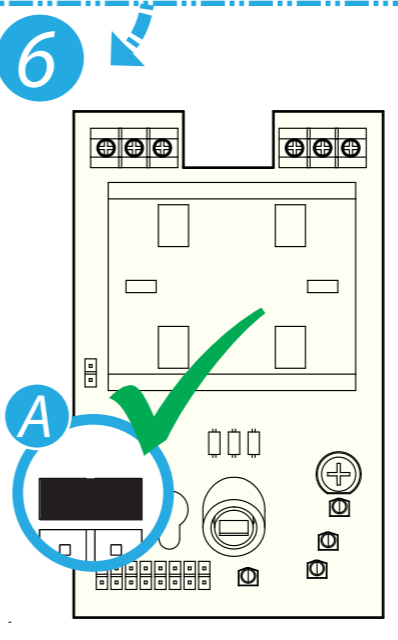
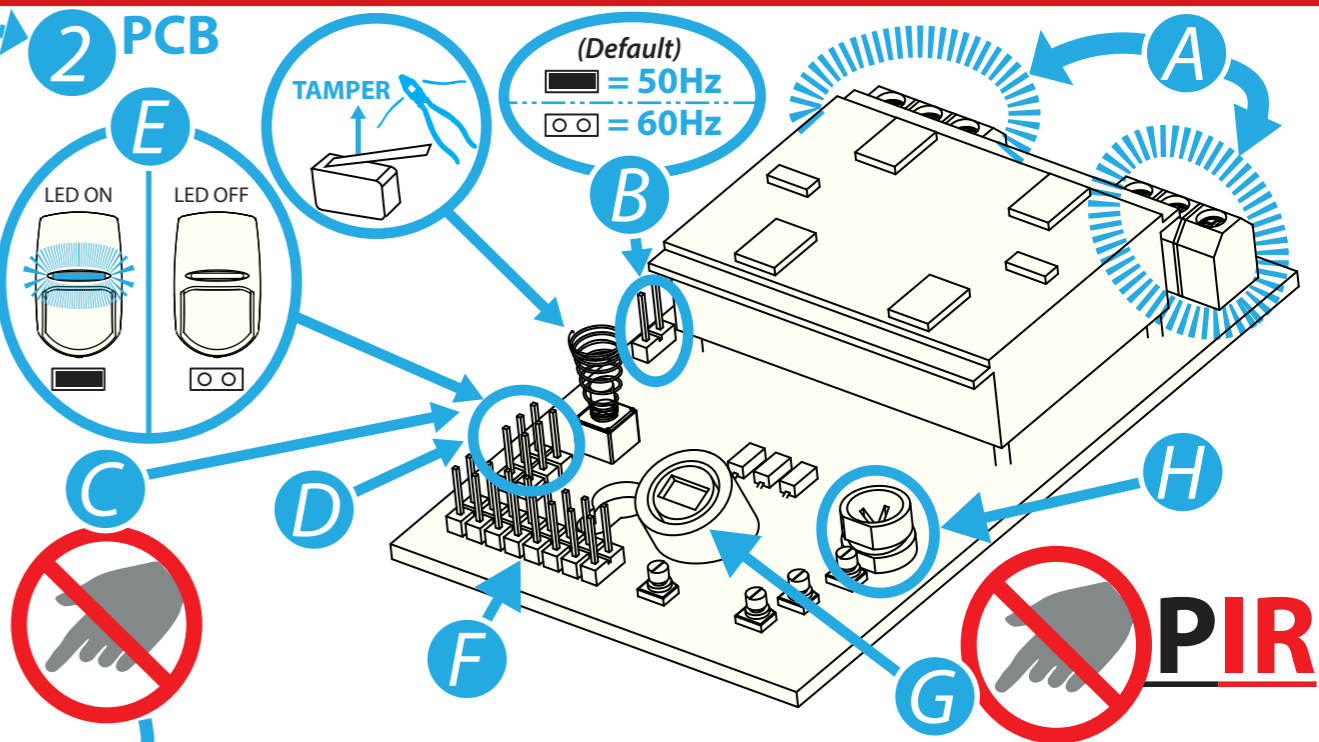
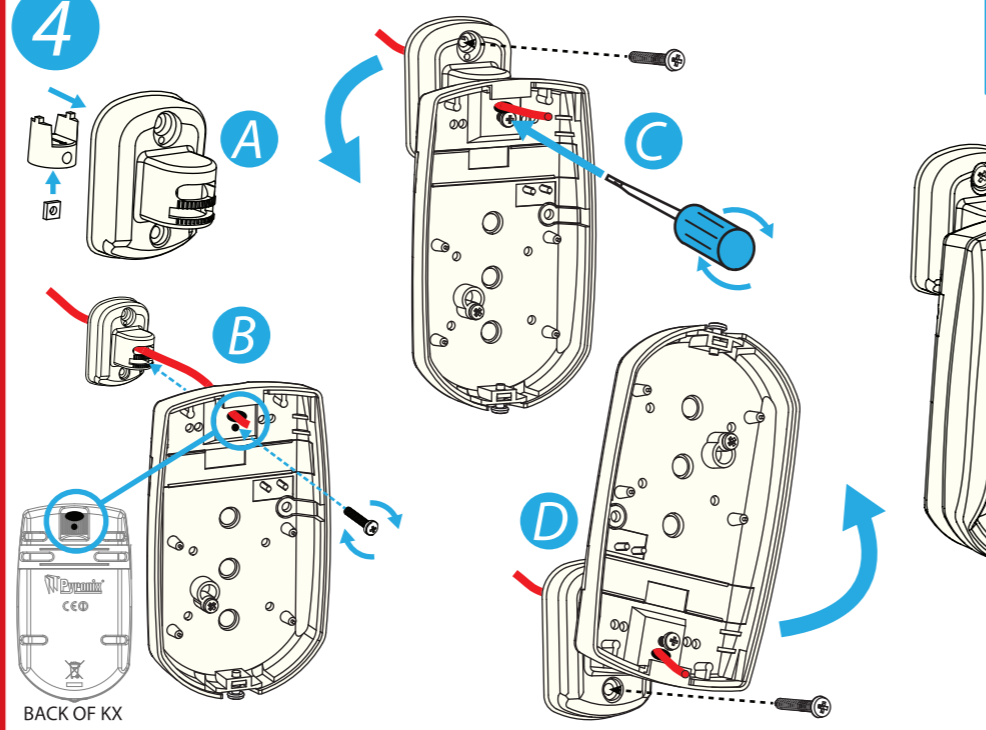
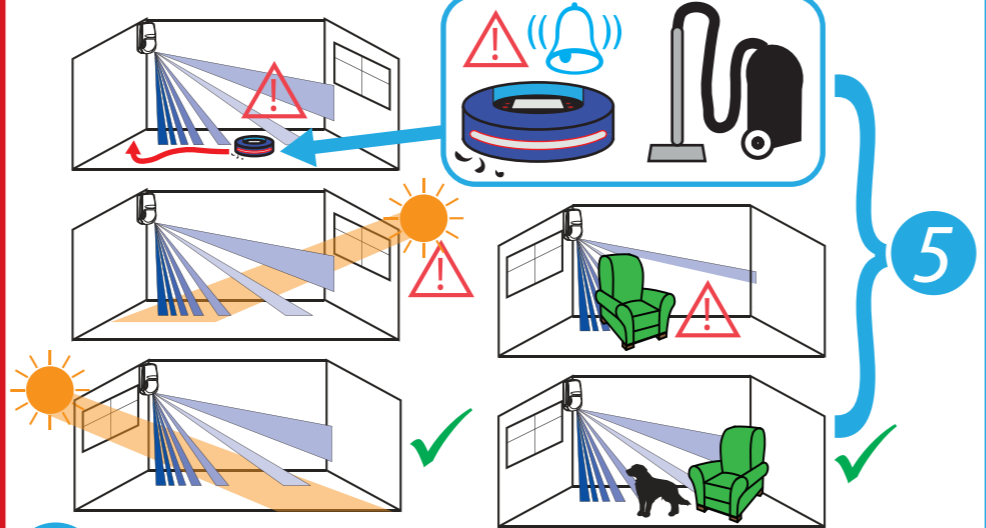
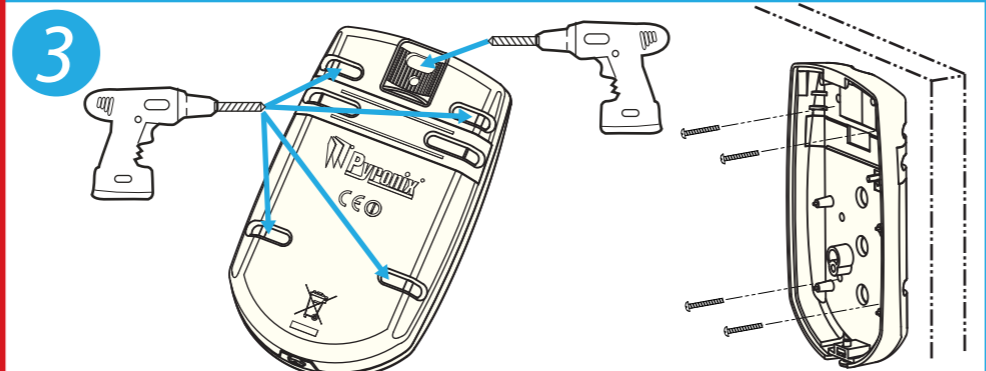
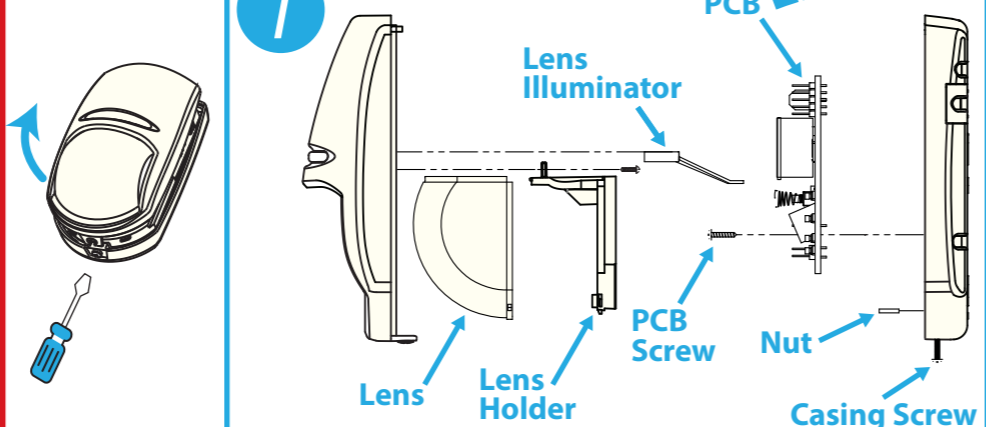

9

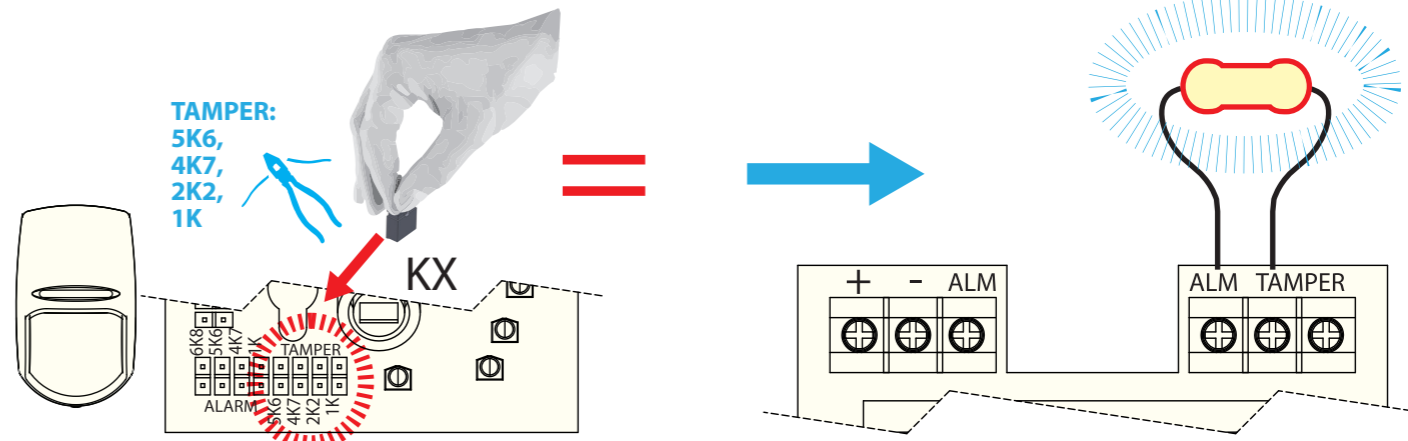
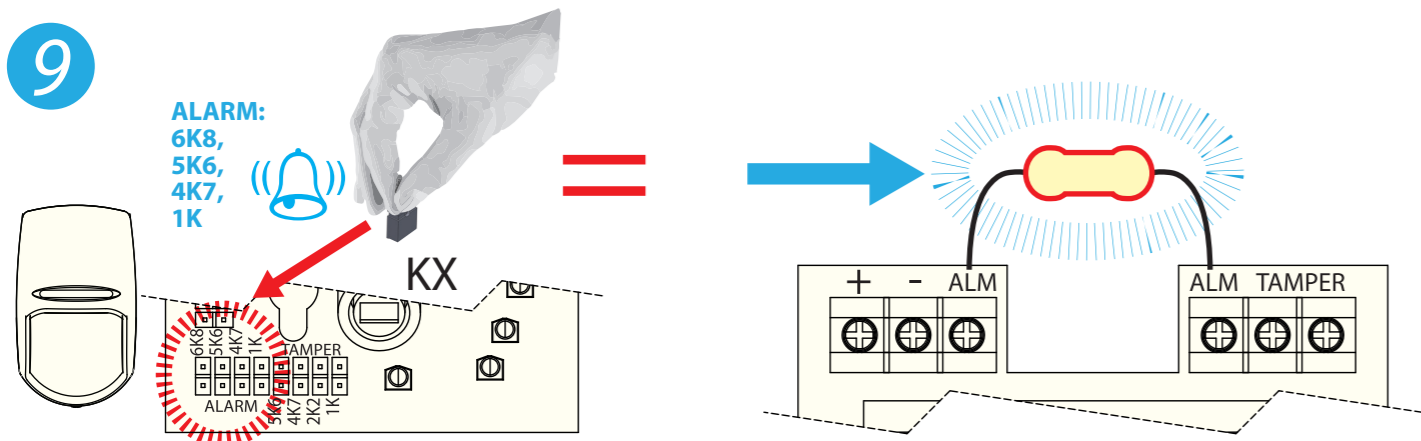

10A

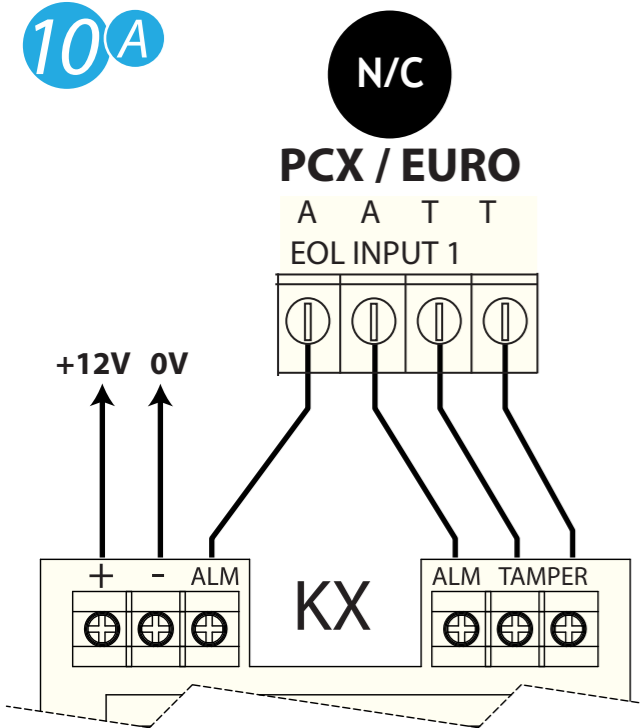

10B

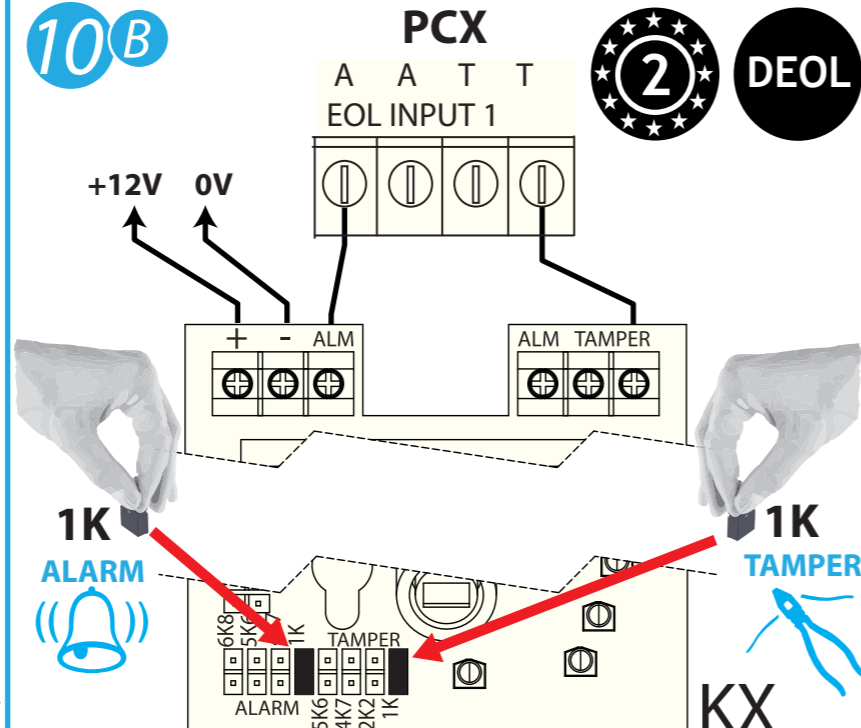

10C

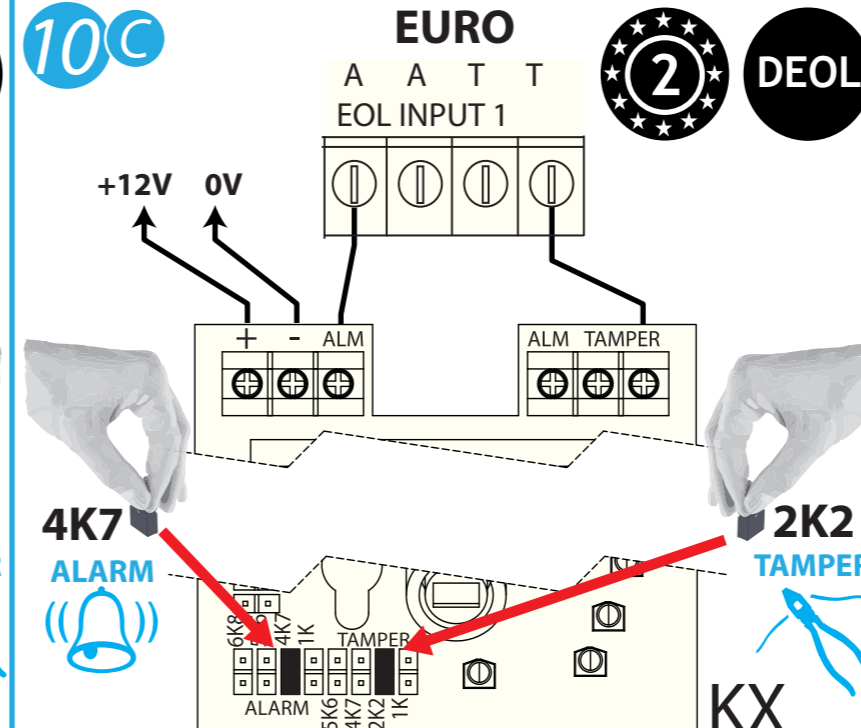

10D

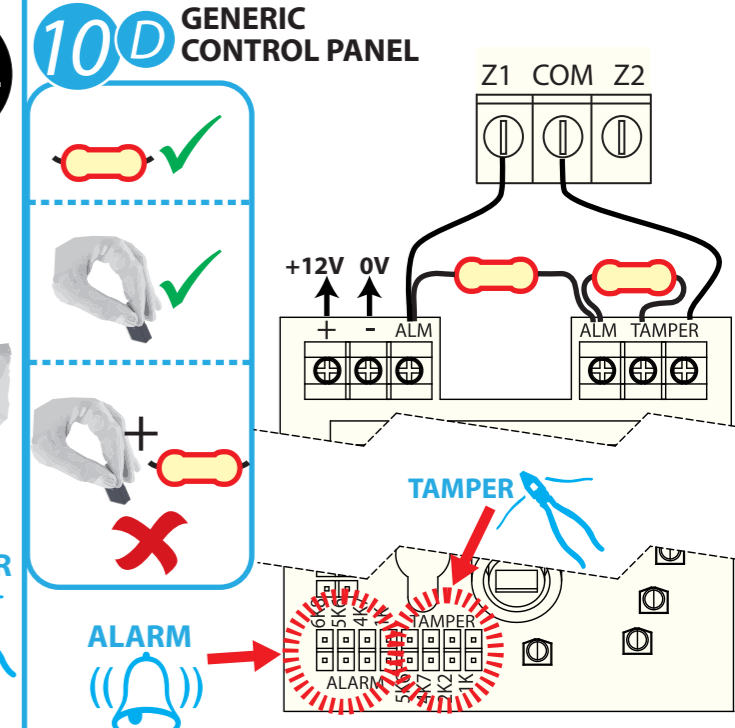

10E

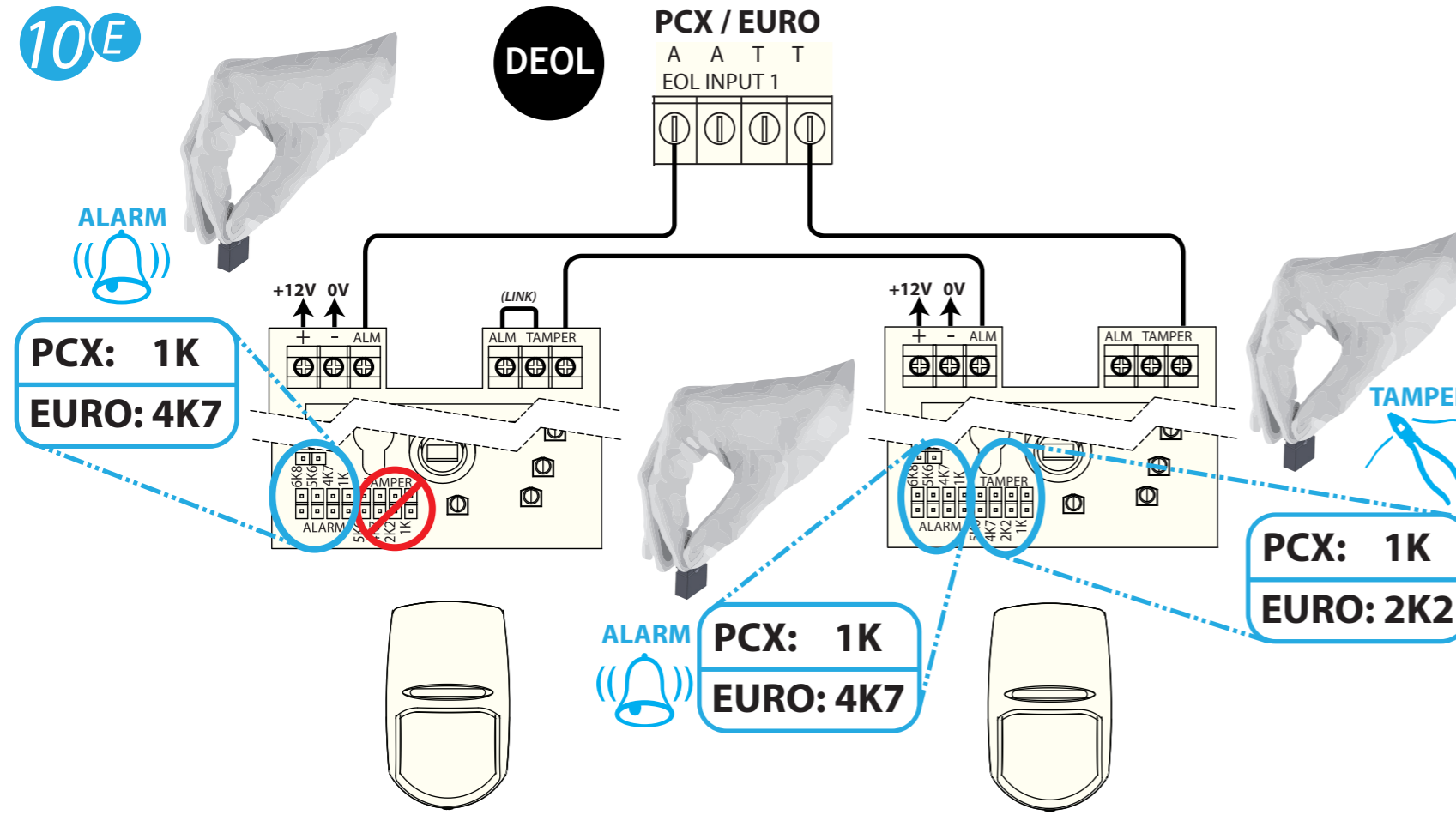

11

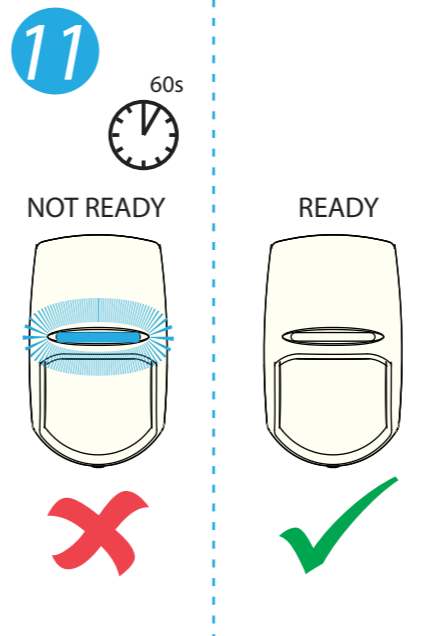

12

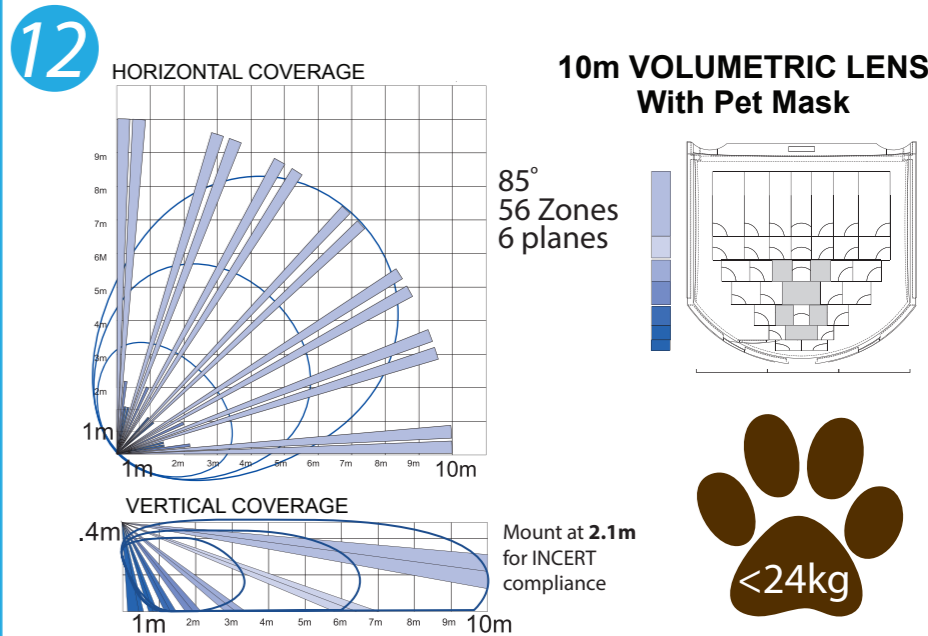

13

